

Data Sheet

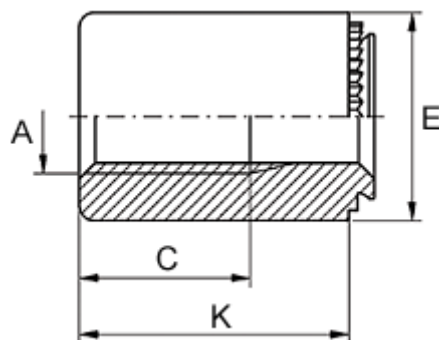

Article number: 12514800130500
Description: KLEE-coil 514 800 130.500
M3 Stainless 1.4305

Measures



| | |
|---------------------------------|--------------|
| Female thread A | = M3 |
| Height K | = 14 |
| Min distance to edge | = 4.0 |
| Outer diameter E | = 7 |
| Plate thickness | = 1.1 to 1.4 |
| Recommended bore diameter +0.05 | = 5.00 |
| Thread length | = 8.0 |